

# READ AND SAVE THESE INSTRUCTIONS

**WARNING:** A risk of fire and electrical shock exists in all electrical appliances and may cause personal injury or death. Please follow all safety instructions.

## Espresso/Cappuccino Maker

**USE AND CARE GUIDE FOR  
MODELS MEXKITB, MEX1B  
AND MEX1BCAN**



# IMPORTANT SAFEGUARDS

When using electrical appliances, basic safety precautions should always be followed to reduce the risk of fire, electric shock and injury to persons, including the following:

- Read all instructions before using appliance.
- Do not touch hot surfaces. Use handles or knobs.
- When in use, the appliance is under pressure and should never be left unattended.
- Do not immerse cord, plug or appliance in water or other liquid. See instructions for cleaning.
- This appliance is not for use by children.
- Close supervision is necessary when any appliance is used near children.
- Unplug from outlet when not in use. Unplug and allow to cool before putting on or taking off parts and before cleaning.
- Do not operate any damaged appliance. Do not operate with a damaged cord or plug, or after the appliance malfunctions or has been dropped or damaged in any manner. Return appliance to the nearest authorized Service Center for examination, repair or adjustment.
- Use attachments only if recommended by the manufacturer.
- Do not use outdoors or while standing in a damp area.
- Do not let cord hang over edge of table or counter or touch hot surfaces.
- Do not place on or near a hot gas or electric burner, or in a heated oven.
- Prior to connecting or disconnecting plug from wall outlet, turn function knob to “**OFF**.”
- Never use the appliance without water.
- Only use appliance as indicated in these instructions.
- Keep steam-jet control knob in closed position when not being used.
- Be certain lids are securely in place before operating appliance.
- Do not unscrew or remove safety lid while the appliance is in operation as scalding may occur. Wait until brewing cycle is completed and all water and steam has been used up.
- **CAUTION:** Relieve pressure through steam tube before removing cup or brew basket.
- The carafe is designed for use with this appliance. It must never be used on a range top.
- Do not set a hot carafe on a wet or cold surface.
- Do not use a cracked carafe or a carafe having a loose or weakened handle.
- Do not clean carafe with abrasive cleansers, steel wool pads, or other abrasive material.

- **WARNING:** Do not remove bottom cover. No user serviceable parts inside. Repair must be done by authorized service personnel only.

# SAVE THESE INSTRUCTIONS

## THIS APPLIANCE IS FOR HOUSEHOLD USE ONLY

**CAUTION:** A short power supply cord is provided to reduce the risk of personal injury resulting from becoming entangled in or tripping over a longer cord. Extension cords are available from local hardware stores and may be used if care is exercised in their use. If an extension cord is required, special care and caution is necessary. Also the cord must be: (1) marked with an electrical rating of 125 V, and at least 13 A., 1625 W., and (2) the cord must be arranged so that it will not drop over the countertop or tabletop where it can be pulled on by children or tripped over accidentally.

**POLARIZED PLUG:** This appliance has a polarized plug, (one blade is wider than the other). As a safety feature to reduce the risk of electrical shock, this plug is intended to fit in a polarized outlet only one way. If the plug does not fit fully in the outlet, reverse the plug, If it still does not fit, contact a qualified electrician. Do not attempt to defeat this safety feature.

**ELECTRIC POWER:** If the electric circuit is overloaded with other appliances, your appliance may not operate properly. It should be operated on a separate electric circuit from other operating appliances.

### Getting to Know Your Espresso/Capuccino Maker

Before using your machine for the first time, you must become familiar with all of the parts. Read all instructions and cautions carefully.

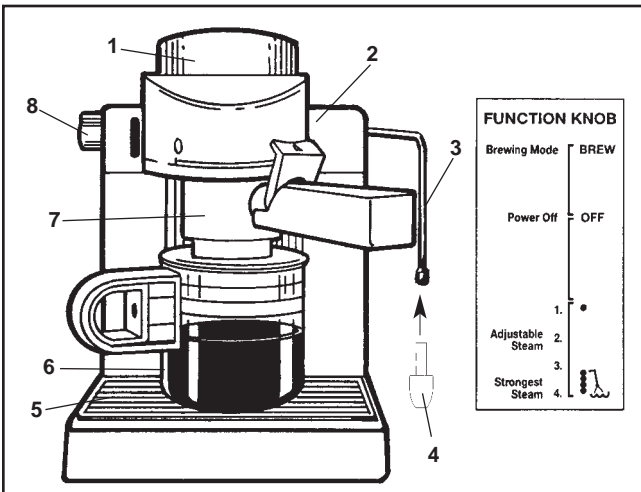

1. Safety lid
2. Water reservoir
3. Steam jet
4. Froth booster tip
5. Drip plate
6. Carafe with lid
7. Filter basket and holder
8. Function knob

**Before making your first carafe of espresso**, we suggest that you let the water brew through the machine two times without coffee, following the instructions. This will thoroughly clean the unit.

# Making Espresso Coffee

1. Make sure the **function knob** is in the “**OFF**” position. Plug the espresso/cappuccino maker into a 120V AC electrical outlet.
2. Remove the safety lid by turning it counter-clockwise and remove from the appliance.
3. For espresso fill carafe to two or four cups of cold water, using the markings on the carafe for reference. For cappuccino, fill the carafe to  for 2 cups or to the bottom of the metal band for 4 cups. Pour water into the water reservoir.
4. Close the safety lid tightly by turning clockwise.
5. Remove the filter basket and holder from the espresso/cappuccino maker by turning clockwise. With the measuring spoon, measure espresso coffee and place into the filter basket. (Do not compress/tap the coffee.)

**NOTE:** Be sure to use coffee which is **MEDIUM TO FINE GROUND**.

6. Place the filter basket into the filter holder.
7. Pull back the tab and insert the filter holder into the brewing head lock aligning the arrow on the filter holder with the  on the machine. Push the filter holder upward so it will be aligned with the matching slots. Turn handle counter-clockwise until securely locked. Place the cover on the carafe and return the carafe to the drip plate. Align hole in lid under filter.
8. Switch the **function knob** to “**BREW**.”
9. After approximately four minutes, espresso coffee will flow into the carafe.

**NOTE:** For cappuccino, refer immediately to the Making Cappuccino section.

10. Do not open the safety lid or remove the filter holder during the brewing process – scalding may occur.
11. When the coffee has stopped flowing into the carafe, turn the **function knob** to the “**OFF**” position.
12. **BEFORE REMOVING THE FILTER HOLDER OR THE SAFETY LID, TURN THE FUNCTION KNOB TO  AND WAIT UNTIL NO FURTHER STEAM EMERGES FROM THE STEAM JET.** Then turn the function knob back to the “**OFF**” position.

# Making Cappuccino

1. Cappuccino is a mixture of espresso coffee, milk and frothed milk. Fill a deep, narrow metal pitcher 1/2 full with fresh, cold milk and set next to the espresso/cappuccino maker.
2. Place the frothing booster tip up over the end of the steam jet. Follow Steps 1 through 9 on page 4 for making espresso.
3. When the coffee starts to flow into the carafe, hold the pitcher by the handle and bring up to the steam jet. Insert froth booster tip *just under the surface of the milk*. Turn the **function knob** gradually to  and froth the milk. Move the pitcher in a slightly circular motion.

**REMINDER:** Before frothing milk, make sure the tip of the froth boother tip is just under the surface of the milk. Otherwise, splattering may occur.

4. After frothing, turn the **function knob** to “**BREW**,” to allow the appliance to complete the espresso making process.
5. Remove the pitcher from the steam jet.
6. When the coffee has stopped flowing into the carafe, turn the **function knob** to the “**OFF**” position.
7. **BEFORE REMOVING THE FILTER HOLDER OR THE SAFETY LID, TURN THE FUNCTION KNOB TO  AND WAIT UNTIL NO FURTHER STEAM EMERGES FROM THE STEAM JET.**  
This will allow any extra steam to be released and will clean the steam jet of any excess milk. Then turn the function knob back to the “**OFF**” position.
8. Serve the hot, frothy milk by spooning it on top of your cup of espresso. The froth will not readily pour from the container, since it separates from the heated milk.

The best frothed milk is obtained when fresh, cold, skim milk is used. When frothing milk, the volume of milk will double.

The top half will be frothed, the bottom half will be milk. Fill a cappuccino cup 1/3 full of freshly brewed espresso coffee. Pour in an equal amount of warm milk and top with frothed milk.

# User Maintenance Instructions

1. Unplug the espresso/cappuccino maker from the electrical outlet and allow to cool **completely** before cleaning.
2. The coffee filter basket and holder should be emptied and rinsed thoroughly with warm water after every use. Dry thoroughly.
3. Clean the carafe and carafe lid with warm, soapy water. **Handle with extreme care, as glass will become slippery when wet.**
4. The carafe drip plate can be removed and washed in warm water.
5. Wipe the outside of your espresso/cappuccino maker with a damp cloth. **NEVER IMMERSER THE APPLIANCE IN WATER OR ANY OTHER LIQUID.**
6. This appliance is for **HOUSEHOLD USE ONLY!**

## Descaling

If you live in a hard-water area, minerals and calcium found in the water will accumulate and affect the operation of your machine. Approximately every six months (this can vary depending on water conditions and frequency of use), your espresso/cappuccino maker should be cleaned with distilled vinegar in the following manner in order to remove the mineral deposits, also referred to as scale.

1. Before cleaning your espresso/cappuccino maker, make sure the **function knob** is in the “**OFF**” position and the appliance has been disconnected from the wall outlet.
2. Fill the carafe with distilled vinegar and pour into the reservoir as you would with water.
3. Securely fasten the safety lid.
4. Attach empty coffee filter basket and holder.
5. Place carafe onto drip plate.
6. Plug the espresso/cappuccino maker into 120V AC electrical outlet.
7. Turn **function knob** to “**BREW.**” In a few minutes, the hot vinegar will start to flow through the coffee basket into the carafe.

# Descaling (Continued)

8. Place steam jet into a tall glass or mug. Move **function knob** to  position during the flowing process only for a few seconds. This will clean any residue left in the tube from the milk steaming process.
9. Turn **function knob** back to “BREW,” permitting the hot vinegar to continue to flow in the carafe.
10. When the flow has stopped, turn **function knob** to “OFF” position and allow to cool completely. Then remove basket, filter, carafe and rinse with hot water.
11. Repeat above steps using cold water to rinse away any residual vinegar. Repeat twice.
12. Turn the **function knob** to the “OFF” position and unplug the espresso/cappuccino maker from the wall outlet.

**Any servicing requiring disassembly other than the above cleaning must be performed by an authorized service center.**

## IMPORTANT NOTICE

*If any parts are missing or defective,  
**DO NOT** return this product.*

*Please call our Customer Service Department for assistance.*

**800-233-9054** Monday - Friday 9:00 am - 5:00 pm CST

*Thank You*

## LIMITED ONE-YEAR WARRANTY

**Warranty Coverage:** This product is warranted to be free from defects in materials or workmanship for a period of one (1) year from the original purchase date. This product warranty is extended only to the original consumer purchaser of the product and is not transferable. For a period of one (1) year from the date of original purchase of the product, our Repair Center will, at its option, either (1) repair the product or (2) replace the product with a reconditioned comparable model. These remedies are the purchaser's exclusive remedies under this warranty.

**Warranty Service:** To obtain warranty service, you must call our warranty service number at 1-800-233-9054 for return instructions on how to deliver the product, in either the original packaging or packaging affording an equal degree of protection to the Repair Center specified below. You must enclose a copy of your sales receipt or other proof of purchase to demonstrate eligibility for warranty coverage.

**To return the appliance, ship to:**

ATTN: Repair Center  
708 South Missouri Street  
Macon, MO 63552 USA

**To contact us, please write to, call, or email:**

Consumer Relations Department  
PO Box 7366  
Columbia MO 65205-7366 USA  
1-800-233-9054  
E-mail:  
consumer\_relations@toastmaster.com

**What Is Not Covered:** This warranty does not cover damage resulting from misuse, accident, commercial use, improper service or any other damage caused by anything other than defects in material or workmanship during ordinary consumer use. This warranty is invalid if the serial number has been altered or removed from the product. This warranty is valid only in the United States and Canada.

**LIMITATION ON DAMAGES:** THERE SHALL BE NO LIABILITY FOR ANY INCIDENTAL OR CONSEQUENTIAL DAMAGES FOR BREACH OF ANY EXPRESS OR IMPLIED WARRANTY OR CONDITION ON THIS PRODUCT.

**DURATION OF IMPLIED WARRANTIES:** EXCEPT TO THE EXTENT PROHIBITED BY APPLICABLE LAW, ALL IMPLIED WARRANTIES AND CONDITIONS, INCLUDING, WITHOUT LIMITATION, IMPLIED WARRANTIES AND CONDITIONS OF MERCHANTABILITY AND FITNESS FOR A PARTICULAR PURPOSE OR USE ON THIS PRODUCT ARE LIMITED IN DURATION TO THE DURATION OF THIS WARRANTY.

Some jurisdictions do not allow the exclusion or limitation of incidental or consequential damages, or allow limitations on how long an implied warranty lasts, so the above limitations or exclusions may not apply to you. This warranty gives you specific legal rights and you may have other rights under the laws of your jurisdiction.

For more information on our products, visit our website: [www.maxim-toastmaster.com](http://www.maxim-toastmaster.com).